



Cat[®] 246C

SKID STEER LOADER

FEATURES:

The Cat[®] 246C Skid Steer Loader, with its radial lift design, delivers excellent digging performance with outstanding drawbar power.

The 246C features the following:

- **Sealed and pressurized cab option** provides a cleaner and quieter operating environment.
- **Seat mounted adjustable joystick controls and available air ride seat** make the C-Series the industry leader in operator comfort.
- **High performance power train** provides high engine horsepower and torque. Electronic Torque Management and standard foot throttle allow the machine to be operated at part throttle for lower sound levels and fuel consumption.
- **High Flow XPS hydraulic system** is available for applications that demand maximum hydraulic work tool performance.
- **Easy routine maintenance** helps reduce machine downtime for greater productivity.
- **Caterpillar's broad range of performance matched work tools** make the Cat Skid Steer Loader the most versatile machine on the jobsite.

Specifications

Engine

Engine Model	Cat [®] 3044C DIT	
Gross Power SAE J1995	56 kW	75 hp
Net Power SAE 1349	54 kW	73 hp
Displacement	3.3 L	201 in ³
Stroke	120 mm	4.7 in
Bore	94 mm	3.7 in

Weights

Operating Weight	3348 kg	7,381 lb
------------------	---------	----------

Power Train

Travel Speed (Forward or Reverse):		
One Speed	12.5 kph	7.7 mph
Two Speed Option	19.3 kph	11.9 mph

Hydraulic System

Hydraulic Flow – Standard:		
Loader Hydraulic Pressure	23 000 kPa	3,335 psi
Loader Hydraulic Flow	84 L/min	22 gal/min
Hydraulic Power	31.9 kW	42.8 hp
Hydraulic Flow – High Flow XPS:		
Max. Loader Hydraulic Pressure	28 000 kPa	4,061 psi
Max. Loader Hydraulic Flow	125 L/min	33 gal/min

Operating Specifications

Rated Operating Capacity	975 kg	2,150 lb
Rated Operating Capacity with Optional Counterweight	1099 kg	2,423 lb
Tipping Load	1950 kg	4,300 lb
Breakout Force, Tilt Cylinder	3324 kg	7,328 lb

Cab

ROPS	SAE J1040 MAY94, ISO 3471:1994
FOPS	SAE J1043 SEPT87, ISO 3449:1992 Level I
FOPS Level II	SAE J231 JAN81, ISO 3449:1992 Level II

Service Refill Capacities

Chain Box, each side	10 L	2.6 gal
Cooling System	14 L	3.7 gal
Engine Crankcase	10 L	2.6 gal
Fuel Tank	98 L	26 gal
Hydraulic System	57 L	15 gal
Hydraulic Tank	42 L	11 gal

246C Skid Steer Loader

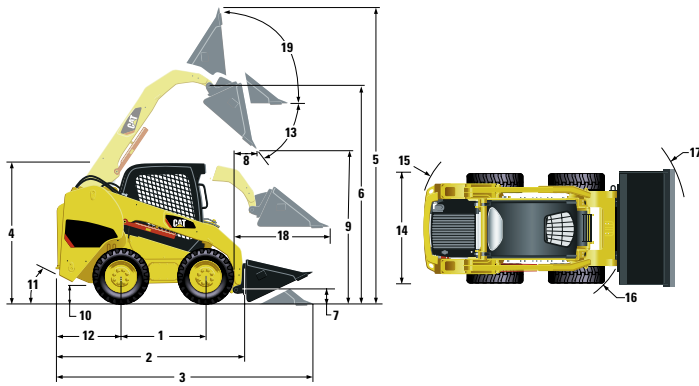

Dimensions

1 Wheelbase	1240 mm	48.8 in
2 Length w/o Bucket	3124 mm	123 in
3 Length w/Bucket on Ground	3692 mm	145.3 in
4 Height to Top of Cab	2083 mm	82 in
5 Max. Overall Height	3998 mm	157.4 in
6 Bucket Pin Height at Max. Lift	3122 mm	122.9 in
7 Bucket Pin Height at Carry Position	200 mm	7.8 in
8 Reach at Max. Lift and Dump	600 mm	23.6 in
9 Clearance at Max. Lift and Dump	2425 mm	95.4 in
10 Ground Clearance	225 mm	8.8 in
11 Departure Angle	26°	
12 Bumper Overhang Behind Rear Axle	1089 mm	42.8 in
13 Maximum Dump Angle	40°	
14 Vehicle Width over Tires	1676 mm	66 in
15 Turning Radius from Center – Machine Rear	1486 mm	58.5 in
16 Turning Radius from Center – Coupler	1629 mm	64.1 in
17 Turning Radius from Center – Bucket	2413 mm	94.9 in
18 Max. Reach w/Arms Parallel to Ground	1388 mm	54.6 in
19 Rack Back Angle at Max. Height	96°	

MANDATORY EQUIPMENT

- Hydraulics, Standard or High Flow XPS
- Quick Coupler, Mechanical or Hydraulic
- Seat Belt, 50 mm (2 in) or 75 mm (3 in)

COMFORT PACKAGE (must select one of the following)

- Open ROPS (C1): *Cup Holder, Radio Ready, Suspension Seat, (No Heater or Door)*
- Enclosed ROPS with Heat (C2): *Cup Holder, Radio Ready, Seat (choice of Suspension or Air Ride), Heater and Defroster, Side Windows, Door (either Glass or Polycarbonate)*
- Enclosed ROPS with A/C (C3): *C2 + Air Conditioner*

PERFORMANCE PACKAGE (must select one of the following)

- Performance Package 1: *One Speed*
- Performance Package 2: *One Speed, Self Level*
- Performance Package 3: *Two Speed, Self Level*
- Performance Package 4: *Two Speed, Self Level, Ride Control, Advanced Machine Information and Control System (AMICS)*

STANDARD EQUIPMENT

ELECTRICAL

- 12 volt Electrical System
- 90 ampere Alternator
- Ignition Key Start/Stop Switch
- Lights: *Gauge Backlighting, Two Rear Tail Lights, Two Rear Working Lights, Two Adjustable Front Halogen Lights, Dome Light*
- Backup Alarm
- Heavy Duty Battery, 850 CCA

OPERATOR ENVIRONMENT

- Gauges: *Fuel Level, Hour Meter*
- Operator Warning System Indicators: *Air Filter Restriction, Alternator Output, Armrest Raised/Operator Out of Seat, Engine Coolant Temperature, Engine Oil Pressure, Glow Plug Activation, Hydraulic Filter Restriction, Hydraulic Oil Temperature, Park Brake Engages*
- Vinyl Seat
- Fold in Ergonomic Contoured Armrest
- Control Interlock System, when operator leaves seat or armrest raised: *Hydraulic System Disables, Hydrostatic Transmission Disables, Parking Brake Engages*
- ROPS Cab, Open, Tilt Up
- FOPS, Level I
- Top and Rear Windows
- Headliner, Deluxe
- Floor Mat
- Interior Rear View Mirror
- 12 volt Electric Socket
- Horn

POWER TRAIN

- Cat® 3044C DIT Tier 2 Compliant Diesel Engine
- Air Cleaner, Dual Element, Radial Seal
- S-O-S™ Sampling Valves, Engine Oil and Hydraulic Oil
- Filters, Spin-on, Hydraulic
- Filters, Bayonet-type, Fuel and Water Separator
- Tilt Up Radiator/Hydraulic Oil Cooler
- Spring Applied, Hydraulically Released, Wet Multi Disc Parking Brakes
- Hydrostatic Transmission
- Four Wheel Chain Drive

OTHER

- Engine Enclosure, Lockable
- Extended Life Antifreeze, -37° C (-34° F)
- Machine Tie Down Points (4)
- Support, Lift Arm
- Hydraulic Oil Level Sight Gauge
- Radiator Coolant Level Sight Gauge
- Radiator, Expansion Bottle
- Caterpillar ToughGuard™ Hose
- Auxiliary, Hydraulics, Continuous Flow
- Heavy Duty, Flat Faced Quick Disconnects
- Split D-Ring to Route Work Tool Hoses Along Side of Left Lift Arm
- Electrical Outlet, Beacon
- Belly Pan Cleanout

OPTIONAL ATTACHMENTS

- Counterweight, increases rated operating capacity 90 kg (200 lb)
- Beacon, Rotating
- Engine Block Heater – 120V or 240V
- Oil, Hydraulic, Cold Operation
- Paint, Custom

For more complete information on Cat products, dealer services, and industry solutions, visit us on the web at www.cat.com

AEHQ5858 (1-07)

© 2007 Caterpillar
All Rights Reserved
Printed in U.S.A.

Materials and specifications are subject to change without notice. Featured machines in photos may include additional equipment. See your Caterpillar dealer for available options.

CAT, CATERPILLAR, their respective logos, "Caterpillar Yellow" and the POWER EDGE trade dress, as well as corporate and product identity used herein, are trademarks of Caterpillar and may not be used without permission.

CATERPILLAR®